

MPI

Course “Parallel Computing”



Wolfgang Schreiner

Research Institute for Symbolic Computation (RISC)

Wolfgang.Schreiner@risc.jku.at

<http://www.risc.jku.at>

JKU
JOHANNES KEPLER
UNIVERSITY LINZ



Message Passing Interface (MPI)

- An API for portable distributed memory programming.
 - Set of library routines, no compiler support needed.
- Official bindings for C and Fortran.
 - Inofficial bindings exist for various other languages.
- Various implementations.
 - MPICH: initial implementation by Argonne National Lab.
 - MVAPICH: MPICH derivative by Ohio State university.
 - Open MPI: merger of various previous implementations.
 - Commercial implementations by HP, Intel, Microsoft.
 - Hardware support: SGI MPT with MPI offload engine.
- Maintained by the MPI Forum.
 - Current Version: MPI 3.1 (June 2015).

See <http://mpi-forum.org/> for the official specification.

MPI Execution Model

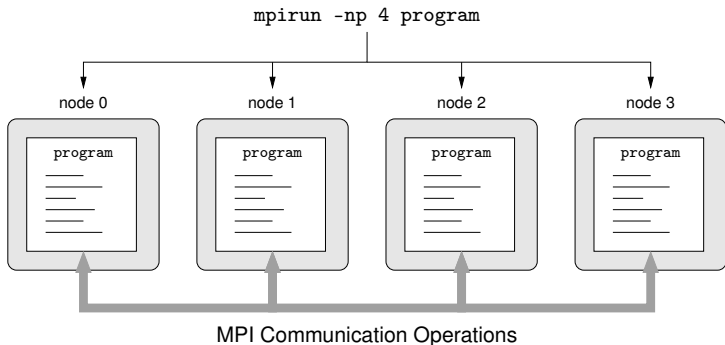

SPMD: Single Program, Multiple Data.

Compiling and Executing MPI

■ Paths (Default):

```
CPATH=...:/opt/sgi/mpt/mpt-2.04/include  
LIBRARY_PATH=...:/opt/sgi/mpt/mpt-2.04/lib  
LD_LIBRARY_PATH=...:/opt/sgi/mpt/mpt-2.04/lib
```

■ Source:

```
#include <mpi.h>
```

■ Intel Compiler:

```
module load intelcompiler/composer_xe_2015.1.133  
icc -std=c99 -Wall -O3 -lmpi matmult.c -o matmult
```

■ GCC:

```
module load GnuCC/7.2.0  
gcc -Wall -O3 -lmpi matmult.c -o matmult
```

■ Execution:

```
export MPI_DSM_CPULIST=32-47  
mpirun -np 16 ./matmult 2048
```

A Sample MPI Program

```
#include <mpi.h>
int main(int argc, char *argv[]) {
    char message[20];
    int size, rank;
    MPI_Init(&argc, &argv);
    MPI_Comm_size (MPI_COMM_WORLD, &size);
    MPI_Comm_rank(MPI_COMM_WORLD, &rank);
    printf("processor %d among %d processors\n", rank, size);
    if (rank == 0) { /* code for process zero */
        strncpy(message,"Hello, there", 19);
        MPI_Send(message, 20, MPI_CHAR, 1, 99, MPI_COMM_WORLD);
    }
    else if (rank == 1) { /* code for process one */
        MPI_Status status;
        MPI_Recv(message, 20, MPI_CHAR, 0, 99, MPI_COMM_WORLD, &status);
        printf("received :%s:\n", message);
    }
    MPI_Finalize();
    return 0;
}
```

Basic Operations

```
int MPI_Init(int *argc, char ***argv)
```

```
int MPI_Comm_size(MPI_Comm comm, int *size)
```

```
IN comm communicator (handle)
```

```
OUT size number of processes in the group of comm (integer)
```

```
int MPI_Comm_rank(MPI_Comm comm, int *rank)
```

```
IN comm communicator (handle)
```

```
OUT rank rank of the calling process in group of comm (integer)
```

```
int MPI_Finalize(void)
```

```
int MPI_Abort(MPI_Comm comm, int errorcode)
```

```
IN comm communicator of tasks to abort
```

```
IN errorcode error code to return to invoking environment
```

Starting a computation, determining its scope, terminating it.

Blocking Send

```
int MPI_Send(const void* buf, int count, MPI_Datatype datatype,  
            int dest, int tag, MPI_Comm comm)
```

```
IN buf        initial address of send buffer (choice)  
IN count      number of elements in send buffer (non-negative integer)  
IN datatype   datatype of each send buffer element (handle)  
IN dest       rank of destination (integer)  
IN tag        message tag (integer)  
IN comm       communicator (handle)
```

Returns when message buffer may be used again; may (but need not) block, if no matching receive statement was issued.

Blocking Receive

```
int MPI_Recv(void* buf, int count, MPI_Datatype datatype,  
            int source, int tag, MPI_Comm comm, MPI_Status *status)
```

OUT buf	initial address of receive buffer (choice)
IN count	number of elements in receive buffer (non-negative integer)
IN datatype	datatype of each receive buffer element (handle)
IN source	rank of source or MPI_ANY_SOURCE (integer)
IN tag	message tag or MPI_ANY_TAG (integer)
IN comm	communicator (handle)
OUT status	status object (Status)

Blocks until a matching message could be received; if more than one message matches, the first one sent is received.

Example: Computing Pi by Throwing Darts

```
#include <mpi.h>
#include <stdio.h>
#include <stdlib.h>

double dboard (int darts);
#define DARTS 50000 /* number of throws */
#define ROUNDS 100 /* number of iterations */
#define MASTER 0 /* task ID of master task */

int main (int argc, char *argv[]) {
    double homepi, pi, avepi, pirecv, pisum;
    int taskid, numtasks, source, mtype, i, n;
    MPI_Status status;

    MPI_Init(&argc,&argv);
    MPI_Comm_size(MPI_COMM_WORLD,&numtasks);
    MPI_Comm_rank(MPI_COMM_WORLD,&taskid);
    printf ("MPI task %d has started...\n", taskid);

    srandom (taskid);
    avepi = 0;
    for (i = 0; i < ROUNDS; i++) {
        homepi = dboard(DARTS);
        if (taskid != MASTER) {
            mtype = i;
            MPI_Send(&homepi, 1, MPI_DOUBLE,
                MASTER, mtype, MPI_COMM_WORLD);
        }
        else {
            /* Master receives messages from all workers */
            /* - Message type set to the iteration count */
            /* - Message source set to wildcard DONTCARE: */
            mtype = i;
            pisum = 0;
            for (n = 1; n < numtasks; n++) {
                MPI_Recv(&pirecv, 1, MPI_DOUBLE,
                    MPI_ANY_SOURCE, mtype, MPI_COMM_WORLD,
                    &status);
                /* keep running total of pi */
                pisum = pisum + pirecv;
            }
            /* Average value of pi for this iteration */
            pi = (pisum + homepi)/numtasks;
            /* Average value of pi over all iterations */
            avepi = ((avepi * i) + pi)/(i + 1);
            printf(" After %8d throws, pi = %10.8f\n",
                (DARTS * (i + 1)),avepi);
        }
    }

    if (taskid == MASTER)
        printf ("\nReal value of PI: 3.1415926535897 \n");
    MPI_Finalize();
    return 0;
}
```

Example: Computing Pi by Throwing Darts

```
#define sqr(x) ((x)*(x))

double dboard(int darts) {

    /* number of hits */
    int score = 0;

    /* throw darts at board */
    for (int n = 1; n <= darts; n++) {

        /* random coordinates in interval [-1,+1] */
        double r = (double)random()/RAND_MAX;
        double x_coord = (2.0 * r) - 1.0;
        r = (double)random()/RAND_MAX;
        double y_coord = (2.0 * r) - 1.0;

        /* if dart lands in circle, increment score */
        if ((sqr(x_coord) + sqr(y_coord)) <= 1.0)
            score++;

    }

    /* calculate pi = 4*(pi*r^2)/(4*r^2) */
    double pi = 4.0 * (double)score/(double)darts;
    return(pi);
}
```

From MPI tutorial at <https://computing.llnl.gov/tutorials/mpi>.

Datatype Constants

MPI_Datatype	MPI_CHAR	char
MPI_Datatype	MPI_INT	signed int
MPI_Datatype	MPI_LONG	signed long int
MPI_Datatype	MPI_FLOAT	float
MPI_Datatype	MPI_DOUBLE	double
MPI_Datatype	MPI_LONG_DOUBLE	long double
...		

Also for all other builtin types.

Derived Datatypes

```
int MPI_Type_contiguous(int count, MPI_Datatype oldtype, MPI_Datatype *newtype)
IN count      replication count (non-negative integer)
IN oldtype    old datatype (handle)
OUT newtype   new datatype (handle)
```

```
int MPI_Type_create_struct(int count, const int array_of_blocklengths[],
    const MPI_Aint array_of_displacements[],
    const MPI_Datatype array_of_types[], MPI_Datatype *newtype)
IN count      number of blocks (non-negative integer)
IN array_of_blocklength  number of elements in each block
    (array of non-negative integer)
IN array_of_displacements  byte displacement of each block
    (array of integer)
IN array_of_types    type of elements in each block
    (array of handles to datatype objects)
OUT newtype          new datatype (handle)
```

```
int MPI_Type_commit(MPI_Datatype *datatype)
INOUT datatype  datatype that is committed (handle)
```

Example

```
double array[1024];

MPI_Datatype array_type;
MPI_Type_contiguous( 1024, MPI_DOUBLE, &array_type );
MPI_Type_commit( &array_type );

MPI_Send(array, 1, array_type, ...);

struct R { int i ; double d; } record;

MPI_Datatype record_type;
int ab[] = { 1, 1 };
MPI_Aint ad[] = { offsetof(struct R, i), offsetof(struct R, d) };
MPI_Datatype at[] = { MPI_INT, MPI_DOUBLE };
MPI_Type_create_struct( 2, ab, ad, at, &record_type );
MPI_Type_commit( &record_type );

MPI_Send(&record, 1, record_type, ...);
```

Blocking Test

```
int MPI_Probe(int source, int tag, MPI_Comm comm, MPI_Status *status)
```

```
IN  source  rank of source or MPI_ANY_SOURCE (integer)
```

```
IN  tag      message tag or MPI_ANY_TAG (integer)
```

```
IN  comm     communicator (handle)
```

```
OUT status  status object (Status)
```

Blocks until a matching message is available (without yet receiving it).

The Return Status

```
typedef struct _MPI_Status {  
    int MPI_SOURCE;  
    int MPI_TAG;  
    int MPI_ERROR;  
    ...  
} MPI_Status;
```

```
int MPI_Get_count(const MPI_Status *status,  
    MPI_Datatype datatype, int *count)
```

IN status return status of receive operation (Status)
IN datatype datatype of each receive buffer entry (handle)
OUT count number of received entries (integer)

Query the sender, tag, and size of a message (to be) received.

Receiving with Incomplete Information

```
MPI_Comm comm = ... ; MPI_Status status = ... ;

MPI_Probe(MPI_ANY_SOURCE, MPI_ANY_TAG, comm, &status);

int source = status.MPI_SOURCE;
int tag = status.MPI_TAG;
MPI_Get_count(status, MPI_INT, &count);

int* buf = malloc(count*sizeof(int));
MPI_Recv(buf, count, MPI_INT, source, tag, comm, &status);
```

Determine the sender, tag, and size of message received.

Controlling Message Buffers

```
int MPI_Buffer_attach(void* buffer, int size)
IN buffer  initial buffer address (choice)
IN size    buffer size, in bytes (non-negative integer)
```

```
int MPI_Buffer_detach(void* buffer_addr, int* size)
OUT buffer  initial buffer address (choice)
OUT size    buffer size, in bytes (non-negative integer)
```

Control buffer to be used for outgoing messages; send operation (typically) only blocks, if buffer is full.

Collective Communication

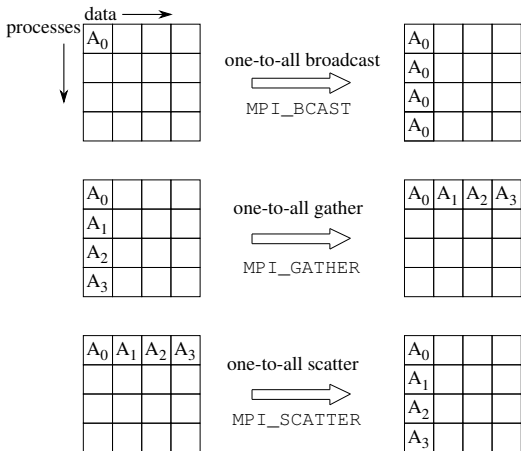

More compact and more efficient programs by the use of collective communication operations.

Broadcast

```
int MPI_Bcast(void* buffer, int count, MPI_Datatype datatype,  
             int root, MPI_Comm comm)
```

INOUT	buffer	starting address of buffer (choice)
IN	count	number of entries in buffer (non-negative integer)
IN	datatype	data type of buffer (handle)
IN	root	rank of broadcast root (integer)
IN	comm	communicator (handle)

Sender (root) and receivers perform the same operation.

Gather

```
int MPI_Gather(const void* sendbuf, int sendcount, MPI_Datatype sendtype,  
              void* recvbuf, int recvcount, MPI_Datatype recvtype,  
              int root, MPI_Comm comm)
```

IN	sendbuf	starting address of send buffer (choice)
IN	sendcount	number of elements in send buffer (non-negative integer)
IN	sendtype	data type of send buffer elements (handle)
OUT	recvbuf	address of receive buffer (choice, significant only at root)
IN	recvcount	number of elements for any single receive (non-negative integer, significant only at root)
IN	recvtype	data type of recv buffer elements (significant only at root) (handle)
IN	root	rank of receiving process (integer)
IN	comm	communicator (handle)

Receiver (root) and senders perform the same operation; also the root is one of the senders.

Gather-to-all

```
int MPI_Allgather(const void* sendbuf, int sendcount, MPI_Datatype sendtype,  
void* recvbuf, int recvcount, MPI_Datatype recvtype,  
MPI_Comm comm)
```

IN	sendbuf	starting address of send buffer (choice)
IN	sendcount	number of elements in send buffer (non-negative integer)
IN	sendtype	data type of send buffer elements (handle)
OUT	recvbuf	address of receive buffer (choice)
IN	recvcount	number of elements received from any process (non-negative integer)
IN	recvtype	data type of receive buffer elements (handle)
IN	comm	communicator (handle)

Every process serves both as a sender and a receiver.

Scatter

```
int MPI_Scatter(const void* sendbuf, int sendcount, MPI_Datatype sendtype,  
               void* recvbuf, int recvcount, MPI_Datatype recvtype,  
               int root, MPI_Comm comm)
```

IN	sendbuf	address of send buffer (choice, significant only at root)
IN	sendcount	number of elements sent to each process (non-negative integer, significant only at root)
IN	sendtype	data type of send buffer elements (significant only at root) (handle)
OUT	recvbuf	address of receive buffer (choice)
IN	recvcount	number of elements in receive buffer (non-negative integer)
IN	recvtype	data type of receive buffer elements (handle)
IN	root	rank of sending process (integer)
IN	comm	communicator (handle)

Sender (root) and receivers perform the same operation; also the root is one of the receivers.

Example: Matrix Multiplication

```
int main(int argc, char* argv[]) {
    MPI_Comm comm = MPI_COMM_WORLD;
    int size, rank;

    MPI_Init(&argc, &argv);
    MPI_Comm_size(comm, &size);
    MPI_Comm_rank(comm, &rank);

    int n;
    if (rank == 0) {
        if (argc != 2) MPI_Abort(comm, -1);
        n = atoi(argv[1]);
        if (n == 0) MPI_Abort(comm, -1);
    }
    MPI_Bcast(&n, 1, MPI_INT, 0, comm);

    // row number n of A is extended to size*n0
    int n0 = n%size == 0 ? n/size : 1+n/size;
    double *A;
    if (rank == 0) {
        A = malloc(size*n0*n*sizeof(double));
        for (int i=0; i<n; i++)
            for (int j=0; j<n; j++)
                A[i*n+j] = rand()%10;
    }
    double* A0 = malloc(n0*n*sizeof(double));
    MPI_Scatter(A, n0*n, MPI_DOUBLE,
               AO, n0*n, MPI_DOUBLE, 0, comm);

    double* B = malloc(n*n*sizeof(double));
    if (rank == 0) {
        for (int i=0; i<n; i++)
            for (int j=0; j<n; j++)
                B[i*n+j] = rand()%10;
    }
    MPI_Bcast(B, n*n, MPI_DOUBLE, 0, comm);

    double* C0 = malloc(n0*n*sizeof(double));
    for (int i=0; i<n0; i++) {
        for (int j=0; j<n; j++) {
            CO[i*n+j] = 0;
            for (int k=0; k<n; k++)
                CO[i*n+j] += A0[i*n+k]*B[k*n+j];
        }
    }

    double* C;
    if (rank == 0)
        C = malloc(size*n0*n*sizeof(double));
    MPI_Gather(C0, n0*n, MPI_DOUBLE,
              C, n0*n, MPI_DOUBLE, 0, comm);
    if (rank == 0) { print(C, n, n); }
    MPI_Finalize();
}
```

Reduction Operations

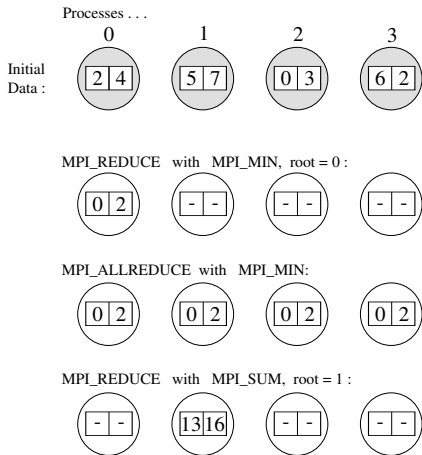

More compact and more efficient programs by the use of reduction operations.

Reduce

```
int MPI_Reduce(const void* sendbuf,  
              void* recvbuf, int count, MPI_Datatype datatype,  
              MPI_Op op, int root, MPI_Comm comm)
```

IN	sendbuf	address of send buffer (choice)
OUT	recvbuf	address of receive buffer (choice, significant only at root)
IN	count	number of elements in send buffer (non-negative integer)
IN	datatype	data type of elements of send buffer (handle)
IN	op	reduce operation (handle)
IN	root	rank of root process (integer)
IN	comm	communicator (handle)

Receiver (root) and senders perform the same operation; also the root is one of the senders.

Predefined Reduction Operations

MPI_MAX	maximum
MPI_MIN	minimum
MPI_SUM	sum
MPI_PROD	product
MPI_LAND	logical and
MPI_BAND	bit-wise and
MPI_LOR	logical or
MPI_BOR	bit-wise or
MPI_LXOR	logical exclusive or (xor)
MPI_BXOR	bit-wise exclusive or (xor)
MPI_MAXLOC	max value and location
MPI_MINLOC	min value and location

Commutative and associative operations; thus the order of reduction does not matter.

User-Defined Reduction Operations

```
int MPI_Op_create(MPI_User_function* user_fn, int commute, MPI_Op* op)
```

```
IN  user_fn  user defined function (function)
```

```
IN  commute  true if commutative; false otherwise.
```

```
OUT op      operation (handle)
```

Turn user-defined function to a reduction operation; must be associative but not necessarily commutative.

Example: Computing Pi by Throwing Darts

```
#include "mpi.h"
#include <stdio.h>
#include <stdlib.h>

double dboard (int darts);
#define DARTS 50000 /* number of throws */
#define ROUNDS 100 /* number of iterations */
#define MASTER 0 /* task ID of master task */

int main (int argc, char *argv[])
{
    double homepi, pisum, pi, avepi;
    int taskid, numtasks, i;
    MPI_Status status;

    MPI_Init(&argc,&argv);
    MPI_Comm_size(MPI_COMM_WORLD,&numtasks);
    MPI_Comm_rank(MPI_COMM_WORLD,&taskid);
    printf ("MPI task %d has started...\n", taskid);

    /* Set seed for random number generator */
    srandom (taskid);

    avepi = 0;
    for (i = 0; i < ROUNDS; i++) {
        /* All tasks calculate pi */
        homepi = dboard(DARTS);

        /* sum values of homepi across all tasks */
        MPI_Reduce(&homepi, &pisum, 1, MPI_DOUBLE,
            MPI_SUM, MASTER, MPI_COMM_WORLD);

        if (taskid == MASTER) {
            pi = pisum/numtasks;
            avepi = ((avepi * i) + pi)/(i + 1);
            printf(" After %8d throws, pi = %10.8f\n",
                (DARTS * (i + 1)),avepi);
        }
    }
    if (taskid == MASTER)
        printf ("\nReal PI: 3.1415926535897 \n");
    MPI_Finalize();
    return 0;
}
```

All-Reduce

```
int MPI_Allreduce(const void* sendbuf,  
                 void* recvbuf, int count, MPI_Datatype datatype,  
                 MPI_Op op, MPI_Comm comm)
```

```
IN  sendbuf    address of send buffer (choice)  
OUT recvbuf    address of receive buffer (choice)  
IN  count      number of elements in send buffer (non-negative integer)  
IN  datatype   data type of elements of send buffer (handle)  
IN  op         reduce operation (handle)  
IN  comm       communicator (handle)
```

Every process serves both as a sender and a receiver.

Example: Finite Difference Problem

```
int main(int argc, char *argv[]) {
    ...
    MPI_Init(&argc, &argv);
    MPI_Comm_size(MPI_WORLD, &np);
    MPI_Comm_rank(MPI_WORLD, &me);

    // read work size and work at process 0
    int size; float* work;
    if (me == 0) {
        size = read_work_size();
        work = malloc(size*sizeof(float));
        read_array(work, size);
    }

    // distribute work size to every process
    MPI_Bcast(&size, 1, MPI_INT, 0, MPI_WORLD);

    // allocate space for local work in every process
    if (size%np != 0) MPI_Abort(MPI_WORLD, -1);
    int lsize = size/np;
    float* lwork = malloc((lsize+2)*sizeof(float));

    // distribute work to all processes
    MPI_Scatter(work, lsize, MPI_FLOAT,
        lwork+1, lsize, MPI_FLOAT, 0, MPI_WORLD);

    // determine neighbors in ring
    int lnbr = (me+np-1)%np;
    int rnbr = (me+1)%np;

    // iterate until convergence
    float globalerr = 99999.0;
    while (globalerr > 0.1) {
        // exchange boundary values with neighbors
        MPI_Send(lwork+1, 1, MPI_FLOAT,
            lnbr, 10, MPI_WORLD);
        MPI_Recv(lwork+lsize+1, 1, MPI_FLOAT,
            rnbr, 10, MPI_WORLD, &status);
        MPI_Send(lwork+lsize, 1, MPI_FLOAT,
            rnbr, 20, MPI_WORLD);
        MPI_Recv(lwork, 1, MPI_FLOAT,
            lnbr, 20, MPI_WORLD, &status);

        // perform local work
        compute(lwork, lsize);

        // determine maximum error among all processes
        float localerr = error(lwork, lsize);
        MPI_Allreduce(&localerr, &globalerr,
            1, MPI_FLOAT, MPI_MAX, MPI_WORLD);
    }

    // collect results at process 0
    MPI_Gather(local+1, lsize, MPI_FLOAT,
        work, lsize, MPI_Float, 0, MPI_WORLD);
    if (me == 0) { write_array(work, size); }
    MPI_Finalize();
}
```

Example: Finite Difference Problem

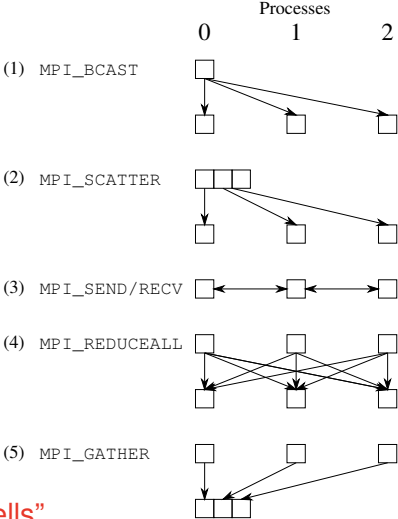
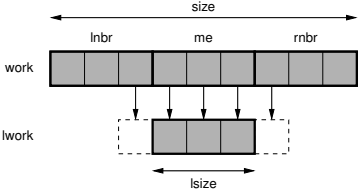

Handle boundaries by “ghost cells”.

Non-Blocking Communication

```
int MPI_Iprobe(int source, int tag, MPI_Comm comm,  
              int *flag, MPI_Status *status)
```

IN source rank of source or MPI_ANY_SOURCE (integer)

IN tag message tag or MPI_ANY_TAG (integer)

IN comm communicator (handle)

OUT flag (logical)

OUT status status object (Status)

Sets flag to “true” if a matching message is pending to be received; otherwise sets flag to “false”.

Example: Managing a Shared Data Structure

```
int READ = 1; int WRITE = 2; int VALUE = 3;
int main(int argc, char *argv[]) {
    MPI_Init(&argc, &argv);
    int *data = ...;
    while (true)
    {
        // check for pending request and process it
        int flag, MPI_Status status;
        MPI_Iprobe(MPI_ANY_SOURCE, MPI_ANY_TAG,
            MPI_COMM_WORLD, &flag, &status);
        if (flag) {
            flag = process(status, data);
            if (flag) continue;
        }

        // perform own work generating requests
        int server; int address; int value;
        ...
        MPI_Send(&address, 1, MPI_INT,
            server, READ, MPI_WORLD);
        MPI_Receive(&value, 1, MPI_INT,
            server, VALUE, MPI_WORLD, &status);
        ...
        int[2] write; write[0] = address; write[1] = value;
        MPI_Send(write, 2, MPI_INT,
            server, WRITE, MPI_WORLD);
    }
    MPI_Finalize();
}

int process(MPI_Status status, int* data) {
    int client = status.MPI_SOURCE;
    int address; int[2] write;
    switch (status.MPI_TAG) {
        case READ:
            MPI_Recv(&address, 1, MPI_INT,
                client, READ, MPI_WORLD, &status);
            MPI_Send(&data[address], 1, MPI_INT,
                client, VALUE, MPI_WORLD);
            return true;
        case WRITE:
            MPI_Recv(write, 2, MPI_INT, client,
                WRITE, MPI_WORLD, &status);
            data[write[0]] = write[1];
            return true;
        default:
            return false;
    }
}
```

Modularity of Program Design

■ Sequential composition:

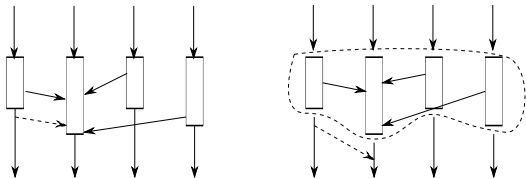

- Message intended for a subsequent phase must not be received by a previous phase.

```
int MPI_Comm_dup(MPI_Comm comm, MPI_Comm *newcomm)
```

```
IN comm      communicator (handle)
```

```
OUT newcomm  copy of comm (handle)
```

```
MPI_Comm comm;
```

```
MPI_Comm_dup(MPI_COMM_WORLD, &comm);
```

```
library_fun(comm);
```

New context for specific phase of program.

Modularity of Program Design

■ Parallel composition:

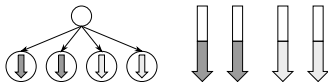

- Message intended for one parallel computation must not interfere with those of another parallel computation.

```
int MPI_Comm_split(MPI_Comm comm, int color, int key, MPI_Comm *newcomm)
IN comm      communicator (handle)
IN color     control of subset assignment (integer)
IN key       control of rank assignment (integer)
OUT newcomm  new communicator (handle)
```

```
MPI_Comm_split(MPI_COMM_WORLD,
  myid%3, myid, &comm);
switch (myid%3) {
  case 0: fun0(comm); break;
  case 1: fun1(comm); break;
  case 2: fun2(comm); break;
}
```

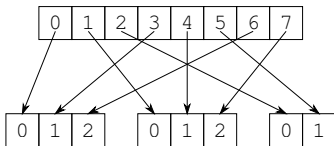

Communicating Between Groups

```
int MPI_Intercomm_create(MPI_Comm local_comm, int local_leader,
    MPI_Comm peer_comm, int remote_leader, int tag, MPI_Comm *newintercomm)
IN local_comm      local intra-communicator (handle)
IN local_leader    rank of local group leader in local_comm (integer)
IN peer_comm       "peer" communicator;
                   significant only at the local_leader (handle)
IN remote_leader   rank of remote group leader in peer_comm;
                   significant only at the local_leader (integer)
IN tag            tag (integer)
OUT newintercomm   new inter-communicator (handle)
```

```
MPI_Comm_split(MPI_COMM_WORLD, myid%2, myid, &comm);
MPI_Comm_rank(comm, &newid);
if (myid%2 == 0) {
    MPI_Intercomm_create(comm, 0, MPI_COMM_WORLD,
        1, 99, &intercomm);
    MPI_Send(message, 1, MPI_INT, newid,
        0, intercomm, &status);
}
else {
    MPI_Intercomm_create(comm, 0, MPI_COMM_WORLD,
        0, 99, &intercomm);
    MPI_Receive(message, 1, MPI_INT, newid,
        0, intercomm, &status);
}
```

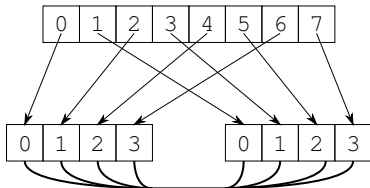

Further MPI Features

- Additional collective operations.
 - All-to-all communication, gathering/scattering with varying data count.
- Specialized communication operations.
 - Forced synchronous, buffered, and nonblocking communication.
- One-sided communications.
- Virtual topologies.
- Dynamic processes.
- Environmental management.
- Parallel input/output.

Mainly added in MPI versions 2 and 3.